

*** SNO GEM PRODUCT CUT SHEET ***

GENERAL NOTES:

1. FOR CLARITY THIS DRAWING IS NOT TO SCALE.
2. CONTACT THE MANUFACTURER FOR RECOMMENDED LAYOUTS, SPACING, AND ADDITIONAL DETAILS.
3. INSTALLATION MUST BE COMPLETED WITH MANUFACTURERS WRITTEN SPECIFICATIONS AND INSTALLATION INSTRUCTIONS.
4. THESE DRAWINGS ARE SUBJECT TO CHANGE WITHOUT NOTICE.

MATERIAL SELECTION:

- ALUMINUM
- STAINLESS STEEL
- BRASS

FINISH SELECTION:

- MILL FINISH
- COLOR TO CLOSELY MATCH

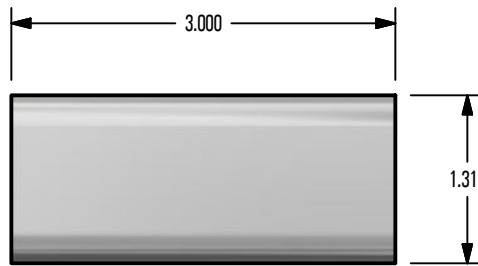
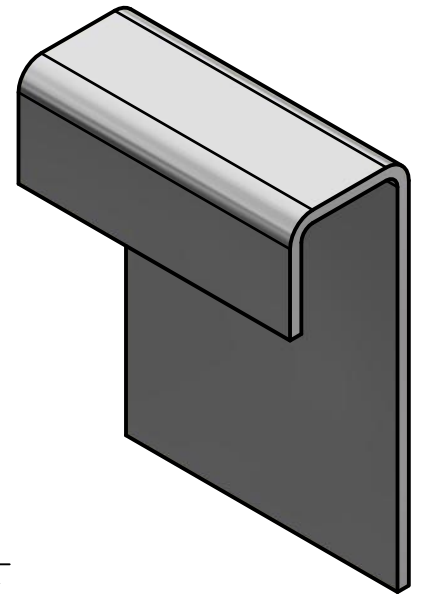

TOP VIEW

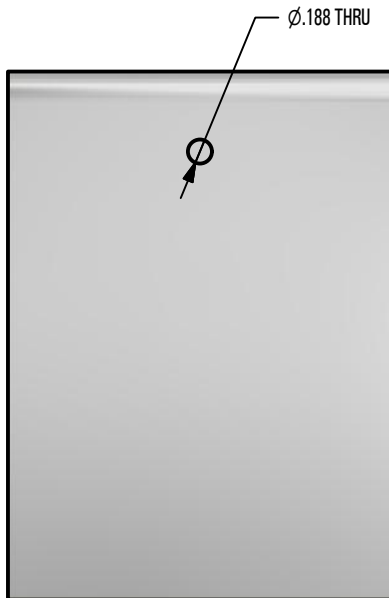

BACK VIEW

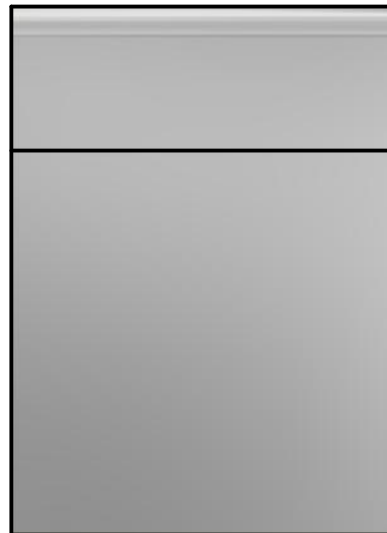

FRONT VIEW

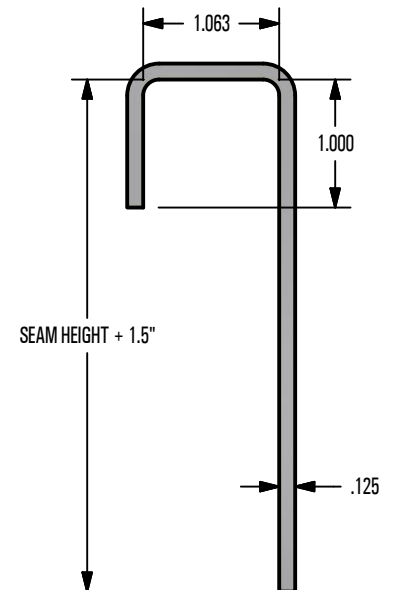

RIGHT VIEW



Raising the Bar in Snow Retention
4800 METALMASTER WAY - MCHENRY, IL 60050

PHONE: 815.477.GEMS WEBSITE: WWW.SNOGEM.COM
 FAX: 815.455.GEMS E-MAIL: INFO@SNOGEM.COM

1 in BLOCKADE PLATE

DRAWN BY:	rhoeffleur
DATE:	1/27/2018
SCALE:	N.T.S.
MATERIAL:	N/A

THE INFORMATION HEREIN IS CONFIDENTIAL AND PROPRIETARY AND IS NOT TO BE DISCLOSED OR DELIVERED TO THIRD PARTIES WITHOUT THE PRIOR WRITTEN CONSENT OF SNO GEM, INC.